

PART NUMBER	DESCRIPTION	2020 LIST
FEHERGUARD "WHEELS" REEL SOLAR ROLLER		
END PACK		
FGIB	Wheels Solar Roller End Pack	\$ 180.90
TUBE PACK		
LI8	Anodized Tube Max Ext. 18' 6"	\$ 290.93
IG20	Anodized Tube Max Ext. 20' 6"	\$ 450.90
LI6M	Mill Tube - Extends to 16'6"	\$ 209.93
LI8M	Mill Tube Max Ext. 18' 6"	\$ 238.95
L20M	Mill Tube Max Ext. 20' 6"	\$ 305.10
FEHERGUARD SOLAR GUARD		
END PACK		
SGI	Feherguard SolarGuard End Pack	\$ 140.20
TUBE PACK		
LI8	Anodized Tube Max Ext. 18' 6"	\$ 290.93
IG20	Anodized Tube Max Ext. 20' 6"	\$ 450.90
FG-PLG	Tubes Plug for 3" Tubes	\$ 27.00
LI6M	Mill Tube - Extends to 16'6"	\$ 209.93
LI8M	Mill Tube Max Ext. 18' 6"	\$ 238.95
L20M	Mill Tube Max Ext. 20' 6"	\$ 305.10
* If buying a SGI with an IG20, FG-PLG is needed		
FEHERGUARD BLANKET HANDLER REEL		
END PACK		
FG-BH	Blanket Handler w/Casters	\$ 148.50
TUBE PACK		
LI8	Anodized Tube Max Ext. 18' 6"	\$ 290.93
IG20	Anodized Tube Max Ext. 20' 6"	\$ 450.90
LC25	Anodized Tube Max Ext. 25'	\$ 777.60
LI6M	Mill Tube - Extends to 16'6"	\$ 209.93
LI8M	Mill Tube Max Ext. 18' 6"	\$ 238.95
L20M	Mill Tube Max Ext. 20' 6"	\$ 305.10
FEHERGUARD PREMIUM AG SOLAR ROLLER		
END PACK		
FG7B	AG Reel Ends	\$ 117.45
TUBE PACK		
LI8	Anodized Tube Max Ext. 18' 6"	\$ 290.93
AG24EX	Aboveground extension 24' 6"	\$ 105.30
AGHD28	Anodized Tube FG7B 28' 6"	\$ 510.30
LI6M	Mill Tube - Extends to 16'6"	\$ 209.93
LI8M	Mill Tube Max Ext. 18' 6"	\$ 238.95
L20M	Mill Tube Max Ext. 20' 6"	\$ 305.10

HOW TO ORDER: To order a complete system select the END plus the telescoping TUBESET(S)

1. Choose End Style (i.e. Wheels Reel)
 2. Choose Tube - based on Pool Size
- * Mill tubes may discolor. This does not affect tube integrity. Anodized tubes help reduce tarnishing.



WHEELS



SOLAR GUARD

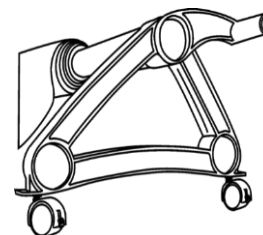

BLANKET HANDLER

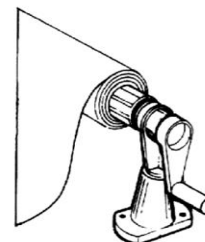

PREMIUM AG ROLLER

* Both LI8 & AG24EX needed to extend to 24' 6" select the END plus the telescoping TUBESET(S)

PART NUMBER	DESCRIPTION	2020 LIST
FEHERGUARD SURFACE RIDER SOLAR ROLLER		
END PACK		
FG-SRE	Surface Rider End	\$ 99.90
TUBE PACK		
FG-SRT18	Surface Rider Tube only 18'	\$ 97.20
FG-SRT24	Surface Rider Tube only 24'	\$ 130.95
FEHERGUARD LOW PROFILE SOLAR ROLLER		
END PACK		
FG3	Low Profile Reel	\$ 237.60
TUBE PACK		
IG20P	Plugged Tube Max Ext. 20' 6"	\$ 488.70
FEHERGUARD AUTO REEL		
END PACK		
FG-AR	Auto Reel-Water Powered	\$ 267.30
TUBE PACK		
LI 8	Anodized Tube Max Ext. 18' 6"	\$ 290.93
IG20	Anodized Tube Max Ext. 20' 6"	\$ 450.90
LI 8M	Mill Tube Max Ext. 18' 6"	\$ 238.95
L20M	Mill Tube Max Ext. 20' 6"	\$ 305.10
FEHERGUARD COMMERCIAL REEL		
END PACK		
FGC	Commercial Metal System	\$ 766.80
TUBE PACK		
CT20	Commercial 20' Tube	\$ 661.50
CT24	Commercial 24' Tube	\$ 742.50
CT30	Commercial 30' Tube	\$ 1,282.50
IMPORT SOLAR ROLLER		
END PACK		
751330	Solar Blanket Roller Base AG	\$ 77.84
751660	Solar Blanket Roller Base I/G	\$ 133.59
TUBE PACK		
7530A	Telescopic Tube 16'-23' Alumin	\$ 217.78
SOLAR ROLLER ACCESSORIES		
FG-FASKIT	Tube Blanket Fastening Kit	\$ 30.24
FG-PFS	TubeBlanket Fasteners-10sets	\$ 15.12
FG-RS26	Reel Strapping-10 Straps26"Pkg	\$ 15.12
FG-RS50	Reel Strapping-1 Roll 50' -Pkg	\$ 30.24
FG-BS2	Blanket Straps-2 X 54" / Pkg.	\$ 18.09
FG-WPS	White Protective Sheet	\$ 23.22
FG-MPR	Mid-Grip Pull Rope	\$ 18.09
FG-VHG	Vacuum Hose Reel	\$ 64.80
751560	Strap (each)	\$ 11.33

HOW TO ORDER: To order a complete system

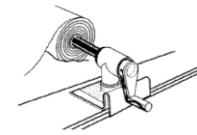

**SURFACE
RIDER**

1. Choose End Style (i.e. Wheels Reel)
 2. Choose Tube - based on Pool Size
- * Mill tubes may discolor. This does not affect tube integrity. Anodized tubes help reduce tarnishing.

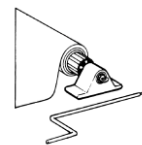

**LOW
PROFILE**



**LOW
PROFILE**



**COMMERCIAL
REEL**

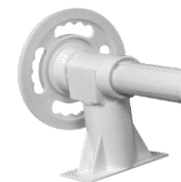

IMPORT SOLAR



FG-FASKIT



FG-RS26



FG-MPR



FG-VHG

PartsWerx Distribution
68 Prince Charles Road
Brantford, Ontario, N3T 5M1
T:1-866-448-WERX(9379)
F:1-866-449-WERX(9379)

PART NUMBER	DESCRIPTION	2020 LIST
LIQUID SOLAR BLANKET		
*Liquid Solar Blanket can now be found on page L-10		
INGROUND 8 YEAR WARRANTY (2 YEAR FULL)		
SBIR14288	14x28 IG Solar Blanket 10y war	\$ 216.38
SBIR16328	16x32 IG Solar Blanket 10y war	\$ 282.62
SBIR18368	18x36 IG Solar Blanket 10y war	\$ 357.70
SBIR20408	20x40 IG Solar Blanket 10y war	\$ 441.60
SBIR24448	24x44 IG Solar Blanket 10y war	\$ 582.91
*other sizes available upon request		
INGROUND 5 YEAR WARRANTY (2 YEAR FULL)		
SBIR12205	12x20 IG Rect Solar Blanket	\$ 110.16
SBIR12245	12x24 IG Rect Solar Blanket	\$ 132.19
SBIR14285	14x28 IG Rect Solar Blanket	\$ 179.93
SBIR16245	16x24 IG Rect Solar Blanket	\$ 176.26
SBIR16325	16x32 IG Rect Solar Blanket	\$ 235.01
SBIR16365	16x36 IG Rect Solar Blanket	\$ 264.38
SBIR18365	18x36 IG Rect Solar Blanket	\$ 297.43
SBIR18405	18x40 IG Rect Solar Blanket	\$ 330.48
SBIR20345	20x34 IG Rect Solar Blanket	\$ 312.12
SBIR20405	20x40 IG Rect Solar Blanket	\$ 367.20
SBIR20445	20x44 IG Rect Solar Blanket	\$ 403.92
SBIR24445	24x44 IG Rect Solar Blanket	\$ 484.70
SBIR25405	25x40 IG Rect Solar Blanket	\$ 459.00
SBIR25505	25x50 IG Rect Solar Blanket	\$ 573.75
SBIR20205	20x20 IG Rect Solar Blanket	\$ 183.60
SBIR24245	24x24 IG Rect Solar Blanket	\$ 264.38
SOLARBLANKET	Custom Solar Blanket per sq ft	\$ 0.45
ABOVEGROUND 3 YEAR WARRANTY (1 YEAR FULL)		
SBAR123	12 ft Round Solar Blanket	\$ 46.66
SBAR153	15 ft Round Solar Blanket	\$ 72.90
SBAR183	18 ft Round Solar Blanket	\$ 104.98
SBAR213	21 ft Round Solar Blanket	\$ 142.88
SBAR243	24 ft Round Solar Blanket	\$ 186.62
SBAR273	27 ft Round Solar Blanket	\$ 254.02
SBAR303	30 ft Round Solar Blanket	\$ 291.60
SBAO12183	12x18 Oval Solar Blanket	\$ 69.98
SBAO12243	12x24 Oval Solar Blanket	\$ 93.31
SBAO15303	15x30 Oval Solar Blanket	\$ 145.80
SBAO16243	16x24 Oval Solar Blanket	\$ 124.42
SBAO16263	16x26 Oval Solar Blanket	\$ 134.78
SBAO16323	16x32 Oval Solar Blanket	\$ 165.89
SBAO18333	18x33 Oval Solar Blanket	\$ 192.46
SBAO18363	18x36 Oval Solar Blanket	\$ 209.95
SOLARBLANKET	Custom Solar Blanket per sq ft	\$ 0.45

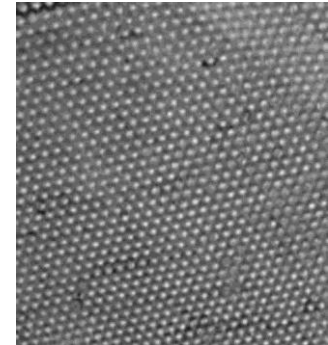

14 MIL SEALED AIR

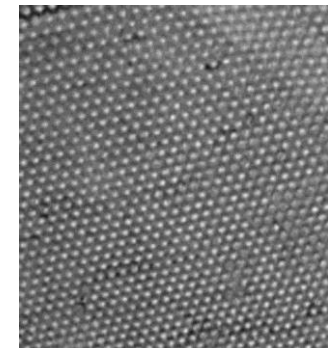

10 MIL SEALED AIR

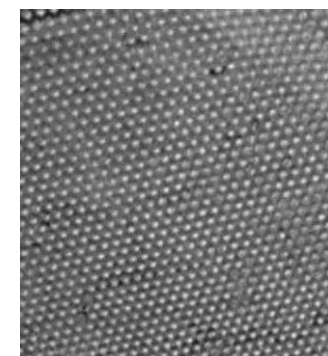

6-7 MIL SEALED AIR

PartsWerx Distribution
68 Prince Charles Road
Brantford, Ontario, N3T 5M1
T:1-866-448-WERX(9379)
F:1-866-449-WERX(9379)

PART NUMBER	DESCRIPTION	2020 LIST
CLEAR INGROUND 5 YEAR WARRANTY (2 YEAR FULL)		
SCIR12205	12x20 Rect Solar Blanket Clear	\$ 115.92
SCIR12245	12x24 Rect Solar Blanket Clear	\$ 139.10
SCIR14285	14x28 Rect Solar Blanket Clear	\$ 189.34
SCIR16245	16x24 Rect Solar Blanket Clear	\$ 185.47
SCIR16325	16x32 Rect Solar Blanket Clear	\$ 247.30
SCIR16365	16x36 Rect Solar Blanket Clear	\$ 278.21
SCIR18365	18x36 Rect Solar Blanket Clear	\$ 312.98
SCIR18405	18X40 Rect Solar Blanket Clea	\$ 347.76
SCIR20345	20x34 Rect Solar Blanket Clear	\$ 328.44
SCIR20405	20x40 Rect Solar Blanket Clear	\$ 386.40
SCIR20445	20x44 Rect Solar Blanket Clear	\$ 425.04
SCIR24405	24x40 Rect Solar Blanket Clear	\$ 463.68
SCIR24445	24x44 Rect Solar Blanket Clear	\$ 510.05
SCIR25405	25x40 Rect Solar Blanket Clear	\$ 483.00
SCIR25505	25x50 Rect Solar Blanket Clear	\$ 603.75
CLEAR ABOVEGROUND 5 YEAR WARRANTY (1 YEAR FULL)		
SCAR125	12ft Round Solar Blanket Clear	\$ 69.55
SCAR155	15ft Round Solar Blanket Clear	\$ 108.68
SCAR185	18ft Round Solar Blanket Clear	\$ 156.49
SCAR215	21ft Round Solar Blanket Clear	\$ 213.00
SCAR245	24ft Round Solar Blanket Clear	\$ 278.21
SCAR275	27ft Round Solar Blanket Clear	\$ 352.11
SCAO12245	12x24 Oval Solar Blanket Clear	\$ 139.10
SCAO16245	16x24 Oval Solar Blanket Clear	\$ 185.47
SCAO16265	16x26 Oval Solar Blanket Clear	\$ 200.93
SCAO16305	16x30 Oval Solar Blanket Clear	\$ 231.84
SCAO16325	16x32 Oval Solar Blanket Clear	\$ 247.30
SCAO18345	18x34 Oval Solar Blanket Clear	\$ 295.60
SCAO18365	18x36 Oval Solar Blanket Clea	\$ 312.98

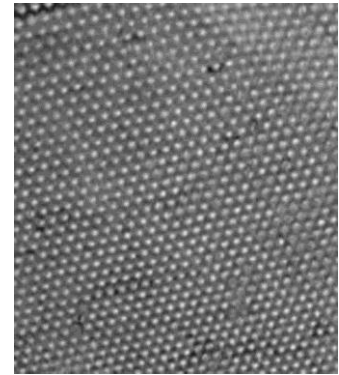

10 MIL SEALED AIR

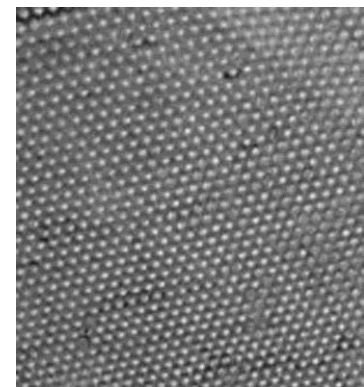

10 MIL SEALED AIR

PartsWerx Distribution
68 Prince Charles Road
Brantford, Ontario, N3T 5M1
T:1-866-448-WERX(9379)
F:1-866-449-WERX(9379)

PART NUMBER POOL SIZE COVER SIZE SETS OF HARDWARE 2020 LIST

STOCK SAFETY COVERS

BLUE RECTANGLE - NO STEP

SAFETYIRI224B	12 X 24	14 X 26	22	\$ 809.85
SAFETYIRI428B	14 X 28	16 X 30	22	\$ 1,502.43
SAFETYIRI632B	16 X 32	18 X 34	24	\$ 1,433.73
SAFETYIRI836B	18 X 36	20 X 38	28	\$ 1,789.32
SAFETYIR2040B	20 X 40	22 X 42	28	\$ 2,029.02

BLUE RECTANGLE - WITH SHALLOW END CENTER STEP

SAFETYIRI428CESB	14 X 28	16 X 30	22	\$ 1,761.81
SAFETYIRI632CESB	16 X 32	18 X 34	24	\$ 1,693.17
SAFETYIRI836CESB	18 X 36	20 X 38	28	\$ 2,048.73
SAFETYIR2040CESB	20 X 40	22 X 42	28	\$ 2,288.43

TAUPE RECTANGLE - NO STEP

SAFETYIRI224T	12 X 24	14 X 26	22	\$ 809.85
SAFETYIRI428T	14 X 28	16 X 30	22	\$ 1,502.43
SAFETYIRI632T	16 X 32	18 X 34	24	\$ 1,433.73
SAFETYIRI836T	18 X 36	20 X 38	28	\$ 1,789.32
SAFETYIR2040T	20 X 40	22 X 42	28	\$ 2,029.02

TAUPE RECTANGLE - WITH SHALLOW END CENTER STEP

SAFETYIRI428CEST	14 X 28	16 X 30	22	\$ 1,761.81
SAFETYIRI632CEST	16 X 32	18 X 34	24	\$ 1,693.17
SAFETYIRI836CEST	18 X 36	20 X 38	28	\$ 2,048.73
SAFETYIR2040CEST	20 X 40	22 X 42	28	\$ 2,288.43

GREY RECTANGLE - NO STEP

SAFETYIRI224G	12 X 24	14 X 26	22	\$ 809.85
SAFETYIRI428G	14 X 28	16 X 30	22	\$ 1,502.43
SAFETYIRI632G	16 X 32	18 X 34	24	\$ 1,433.73
SAFETYIRI836G	18 X 36	20 X 38	28	\$ 1,988.14
SAFETYIR2040G	20 X 40	22 X 42	28	\$ 2,029.02

* Approximate 5'x5' Sections. Includes all necessary hardware, installation rod, anchor key & storage bag

* 3'x3' Std Mesh = 15year Warranty, 5'x5' Std Mesh = 12year Warranty, 3'x3' or 5'x5' Solid = 10year Warranty

**** FOR ALL CUSTOM SAFETY COVERS PLEASE CALL FOR A QUOTE ****

Custom safety covers available. Contact Partswerx for a quote. Double springs standard on all CUSTOM safetycovers



SAFETY COVERS



SAFETY COVERS WITH CENTER STEP

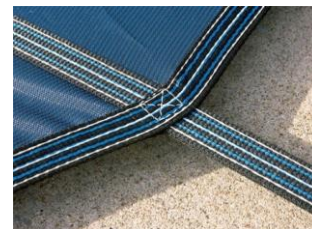

INGROUND BEADED VINYL HANGING COVER

POOL SIZE	2020 LIST
12 X 24	\$ 308.16
14 X 28	\$ 419.44
16 X 24	\$ 410.88
16 X 32	\$ 547.84
16 X 36	\$ 616.32
18 X 36	\$ 693.36
20 X 34	\$ 727.60
20 X 40	\$ 856.00
20 X 44	\$ 941.60
25 X 50	\$ 1,337.50
BEADED STAIR COVER	\$ 53.55
CUSTOM PER SQUARE FOOT (Measure longest point to widest point)	\$ 1.07
* All vinyl covers carry a 5 year pro rated warranty	
* All vinyl cover material is pure 100% virgin vinyl	
* 12 mil cover includes a 12", 20 mil beaded wall	
* Fully sanitized and winterized	
All warranty claims to be handled with the manufacturer	
** PRICING SUBJECT TO CHANGE **	
** PRICES WILL CHANGE ON AUGUST 1ST DUE TO MARKET CONDITIONS **	



**BEADED VINYL
COVER**

INGROUND BEADED FABRENE COVERS

POOL SIZE	COVER SIZE	2020 LIST
12 X 24	16 X 28	\$ 645.12
14 X 28	18 X 32	\$ 933.12
16 X 24	20 X 28	\$ 806.40
16 X 36	20 X 40	\$ 1,152.00
18 X 36	22 X 40	\$ 1,267.20
20 X 34	24 X 38	\$ 1,313.28
20 X 40	24 X 44	\$ 1,520.64
20 X 44	24 X 48	\$ 1,658.88
25 X 50	29 X 54	\$ 2,255.04
BEADED STAIR COVER		\$ 53.55
CUSTOM PER SQUARE FOOT (Measure Longest Point To Widest Point)		\$ 1.44
* Pricing is based on Cover Size (Please add 4' to pool length and width to calculate cover size)		
All warranty claims to be handled with the manufacturer		
** PRICES WILL CHANGE ON AUGUST 1ST DUE TO MARKET CONDITIONS **		



**BEADED FABRENE
COVER**

WINTER COVERS

INGROUND - 6' overlap, grommets every 3'

SIZE	PART NUMBER	10 YEAR	PART NUMBER	14 YEAR
12 X 24	WCIR122410	\$ 110.47	WCIR122414	\$ 191.81
14 X 28	WCIR142810	\$ 139.06	WCIR142814	\$ 241.61
16 X 32	WCIR163210	\$ 158.57	WCIR163214	\$ 292.47
16 X 36	WCIR163610	\$ 189.00	WCIR163614	\$ 328.29
18 X 36	WCIR183610	\$ 206.16	WCIR183614	\$ 358.09
20 X 40	WCIR204010	\$ 244.60	WCIR204014	\$ 424.88
20 X 44	WCIR204410	\$ 265.88	WCIR204414	\$ 461.86
25 X 50	WCIR255010	\$ 355.08	WCIR255014	\$ 616.79



WINTER COVERS

ABOVEGROUND - ROUND

SIZE	PART NUMBER	10 YEAR	PART NUMBER	14 YEAR
12' Round	WCAR1210	\$ 58.03	WCAR1214	\$ 90.96
15' Round	WCAR1510	\$ 81.90	WCAR1514	\$ 128.23
18' Round	WCAR1810	\$ 107.97	WCAR1814	\$ 171.91
21' Round	WCAR2110	\$ 141.75	WCAR2114	\$ 222.10
24' Round	WCAR2410	\$ 171.99	WCAR2414	\$ 269.93
27' Round	WCAR2710	\$ 218.00	WCAR2714	\$ 341.40
30' Round	WCAR3010	\$ 262.18	WCAR3014	\$ 410.71

4' overlap, grommets every 3'



AG WINTER COVERS

WINTER COVERS

ABOVEGROUND - OVAL

SIZE	PART NUMBER	10 YEAR	PART NUMBER	14 YEAR
12x18 Oval	WCAO121810	\$ 79.80	WCAO121814	\$ 125.03
12x24 Oval	WCAO122410	\$ 101.66	WCAO122414	\$ 159.20
15x24 Oval	WCAO152410	\$ 120.70	WCAO152414	\$ 189.00
15x30 Oval	WCAO153010	\$ 146.58	WCAO153014	\$ 229.48
16x26 Oval	WCAO162610	\$ 136.10	WCAO162614	\$ 213.17
16x32 Oval	WCAO163210	\$ 163.34	WCAO163214	\$ 255.78
18x33 Oval	WCAO183310	\$ 184.65	WCAO183314	\$ 289.17

4' overlap, grommets every 3'



AG WINTER COVERS

ULTIMATE COVERS (12 YEAR WARRANTY)

SIZE	PART NUMBER	2020 LIST
ROUND		
12' Round	UPC12R	\$ 254.46
15' Round	UPC15R	\$ 331.98
18' Round	UPC18R	\$ 396.66
21' Round	UPC21R	\$ 477.20
24' Round	UPC24R	\$ 582.02
28' Round	UPC28R	\$ 656.05
30' Round	UPC30R	\$ 706.23
33' Round	UPC33R	\$ 761.55



PartsWerx Distribution
68 Prince Charles Road
Brantford, Ontario, N3T 5M1
T:1-866-448-WERX(9379)
F:1-866-449-WERX(9379)

ULTIMATE COVERS (12 YEAR WARRANTY)

OVAL		
12 X 18	UPCI218OV	\$ 275.29
12 X 24	UPCI224OV	\$ 350.40
15 X 24	UPCI524OV	\$ 416.08
15 X 30	UPCI530OV	\$ 595.11
16 X 26	UPCI626OV	\$ 476.26
16 X 32	UPCI632OV	\$ 673.31
18 X 34	UPCI834OV	\$ 743.82

LEAF NETS (2 YEAR WARRANTY)

SIZE	PART NUMBER	2020 LIST
INGROUND		
12 X 24	LNIR12242	\$ 146.41
14 X 28	LNIR14282	\$ 188.24
16 X 24	LNIR16242	\$ 183.01
16 X 32	LNIR16322	\$ 217.43
16 X 36	LNIR16362	\$ 261.44
18 X 36	LNIR18362	\$ 287.58
20 X 40	LNIR20402	\$ 318.89
20 X 44	LNIR20442	\$ 376.47
25 X 50	LNIR25502	\$ 511.77

LEAF NETS (2 YEAR WARRANTY)

SIZE	PART NUMBER	2020 LIST
ABOVEGROUND		
12' Round	LNAR122	\$ 64.05
15' Round	LNAR152	\$ 94.45
18' Round	LNAR182	\$ 120.79
21' Round	LNAR212	\$ 172.88
24' Round	LNAR242	\$ 204.14
27' Round	LNAR272	\$ 274.84
30' Round	LNAR302	\$ 334.64
12x24 Oval	LNAO12242	\$ 118.96
15x30 Oval	LNAO15302	\$ 177.78
16x26 Oval	LNAO16262	\$ 164.71
16x32 Oval	LNAO16322	\$ 200.00
18x33 Oval	LNAO18332	\$ 228.76

All warranty claims to be handled with the manufacturer
 ** PRICES WILL CHANGE ON AUGUST 1ST DUE TO MARKET CONDITIONS **



ULTIMATE COVERS



IG LEAF NETS



AG LEAF NETS

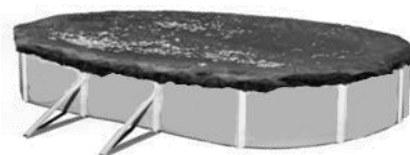

FEHERGUARD "WHEELS" REEL PARTS

	PART NUMBER		DESCRIPTION	2020 LIST
	1	FG-PLG	Tubes Plug for 3" Tubes	\$ 27.00
	2	FG-PLGL	Tubes Plug for 2 1/2" Tubes	\$ 22.28
	3	FG-BEA005	Bearing -BL-IGEW-FG1BFG7B	\$ 24.30
	4	FG-B-HAN	Handle -FG1B - (FG7B)	\$ 39.15
	5	FG-502	Wheel - 20" FG1B each	\$ 75.60
	6	FG-002	Wheel Stop-FG1B ea	\$ 39.15

FEHERGUARD BLANKET HANDLER PARTS

	PART NUMBER		DESCRIPTION	2020 LIST
	1	FG-PLG	Tubes Plug for 3" Tubes	\$ 27.00
	2	FG-PLGL	Tubes Plug for 2 1/2" Tubes	\$ 22.28
	3	FG-BEA005	Bearing -BL-IGEW-FG1BFG7B	\$ 24.30
	4	FG-B-HANC	Curved Handle-BL-IGEW	\$ 39.15
	5	FG-202	End Bracket For BL-IGEW	\$ 75.60
	6	FG-CK	Casters- Blanket Handler-2"x4	\$ 29.70

FEHERGUARD PREMIUM AG ROLLER PARTS

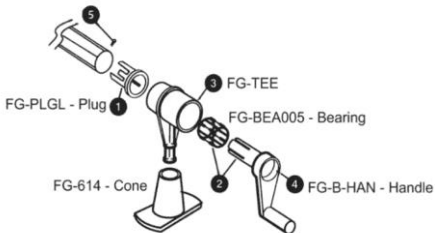
	PART NUMBER		DESCRIPTION	2020 LIST
	1	FG-PLGL	Tubes Plug for 2 1/2" Tubes	\$ 22.28
	2	FG-BEA005	Bearing -BL-IGEW-FG1BFG7B	\$ 24.30
	3	FG-TEE	T for PREMIUM (FG7B)	\$ 39.15
	4	FG-B-HAN	Handle -FG1B - (FG7B)	\$ 39.15
		FG-614	AG CONE for FG7B	\$ 39.15

FEHERGUARD SURFACE RIDER ROLLER PARTS

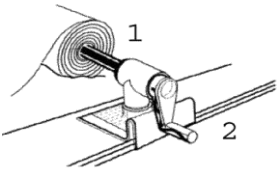
	PART NUMBER		DESCRIPTION	2020 LIST
	1	FG-SRE-AXLEND	AXLE END-Surface Rider (SRE)	\$ 60.75
	2	FG-SRE-HANEND	Handle END-Surface Rider-SRE	\$ 74.25

COMPETITION "WHEELS" REEL PARTS

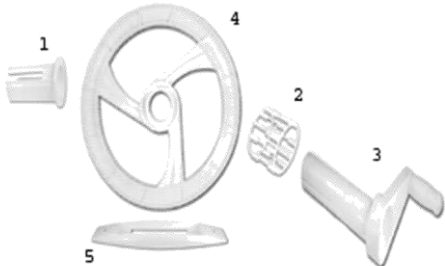
	PART NUMBER		DESCRIPTION	2020 LIST
	1	731673	Competition"Wheels" - Hub	\$ 3.58
	2	FG-BEA005	Bearing -BL-IGEW-FG1BFG7B	\$ 24.30
	3	731671	Handle	\$ 15.85
	4	731674	Competition "Wheels" - Wheel	\$ 44.63
	5	731675	Competition "Wheels" - Base	\$ 8.86

OLYMPIC/COMPETITION SOLAR REEL PARTS

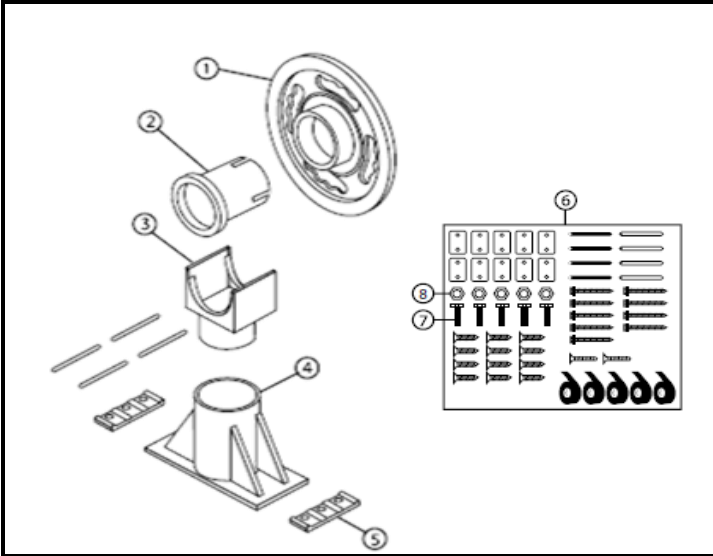

PART NUMBER		DESCRIPTION	2020 LIST
1	BUL-1001	Competition "Wheels" - Base	\$ 33.46
2	BUL-1002	Competition "Wheels" - Base	\$ 12.62
3	BUL-1003	AXLE END-Surface Rider (SRE)	\$ 12.13
4	BUL-1004	Handle for A/G Solar Roller	\$ 25.29
4	BUL-1005	A/G Solar Roller Hub - White	\$ 47.79
5	BUL-1006	Yoke -White - A/G Solar Roller	\$ 3.43
6	BUL-133-1	Solar Roller Base (White)	\$ 22.57
6	BUL-166-1	Base for ACM-166	\$ 31.62
6	BUL-1021	Base attachment Olympic AG2pk	\$ 3.22

SAFETY COVER PARTS

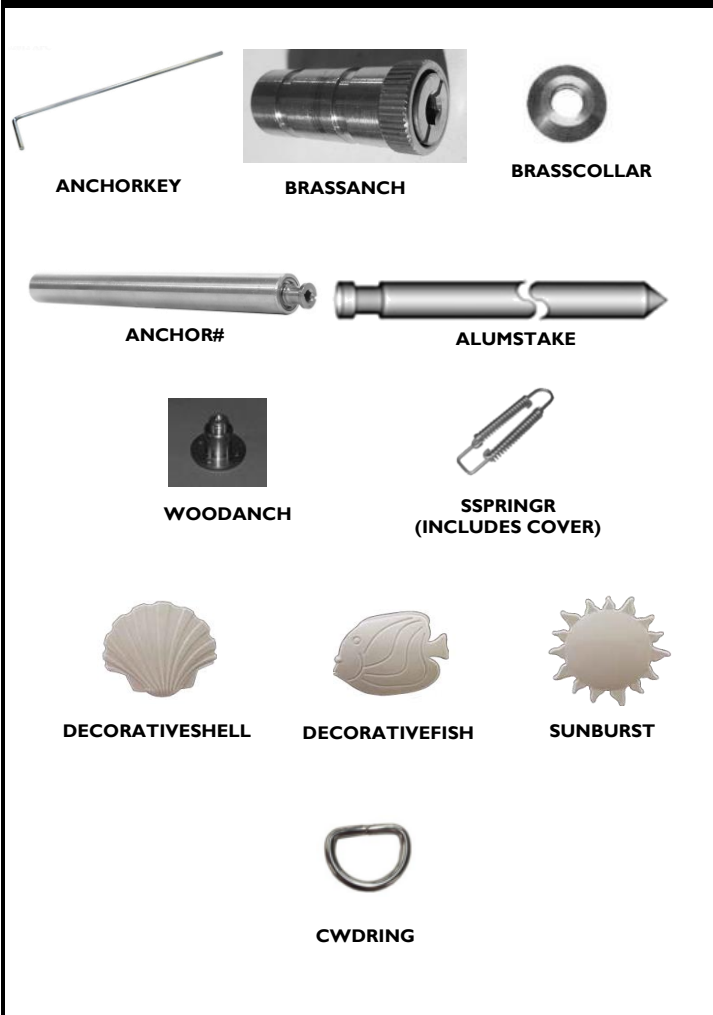

PART NUMBER		DESCRIPTION	2020 LIST
ANCHORKEY		Allen Keys	\$ 14.10
ANCHOR8		Paver Tube w/Anchor 8"	\$ 23.45
ANCHOR15		Paver Tube w/Anchor 15"	\$ 23.45
WOODANCH		Wood Deck Anchors (w/Screw)	\$ 15.15
BRASSCOLLAR		Brass Collar	\$ 3.85
BRASSANCH		Brass Anchors (Each)	\$ 10.46
BUCKLE		Stainless Steel Buckles	\$ 2.50
INSTALLROD		Safety Cover Installation Rod	\$ 29.60
VINSPRCOV		Vinyl Tube Spring Cover	\$ 4.35
SSPRINGR		Stainless Single Spring 6-5/8"	\$ 8.98
SSPRINGS		Stainless Spring Short5"Single	\$ 11.83
ALUMSTAKE		Aluminum Stakes	\$ 11.53
DECORATIVESHELL		Decorative Shell Anchor Covers	\$ 17.85
DECORATIVEFISH		Decorative Fish Anchor Covers	\$ 17.85
SUNBURST		Sunburst Anchor Covers	\$ 17.85
TAMPTOOL		Tamp Tool Aluminum	\$ 5.16
SCPATCHB		Safety Cover Patch Blue Mesh	\$ 47.85
SCPATCHBK		Safety Cover Patch Black	\$ 47.85
SCPATCHGR		Safety Cover Patch Grey Mesh	\$ 47.85
SCPATCHG		Safety Cover Patch Green Mesh	\$ 47.85
SCPATCHT		Safety Cover Patch Tan Mesh	\$ 47.85
CWDRING		Safety Cover "D" Ring	\$ 1.22